

Top View

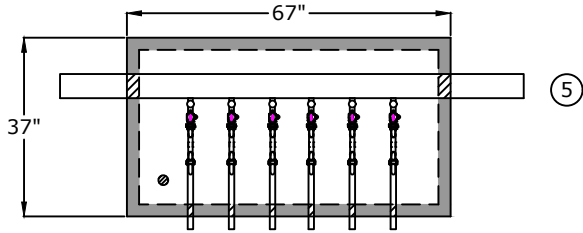

1. Corporation Stop
AY $\frac{3}{4}$ " 74101BCAPP (300 PSI)
2. Meter Setter
AY $\frac{3}{4}$ " 720-207WDDD 33
3. Brass Nipples
AY $\frac{3}{4}$ " x 4"
AY $\frac{3}{4}$ " x 18"
(poly wrap through wall)
4. 29" x 59" opening single leaf drop-in aluminum door, pedestrian rated (300 lb/ft²)
5. 4" D.I.P. Class 56 / PR 350
6. 2" drain hole

Side View

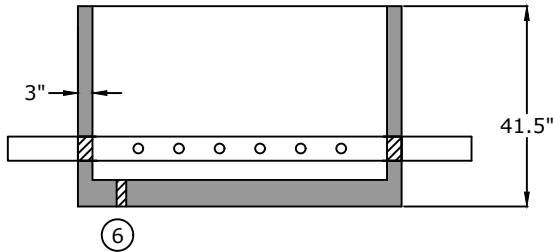

Component Detail

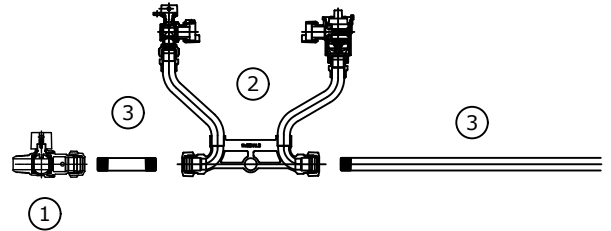

End View

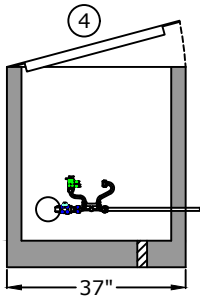

Pipe detail for taps

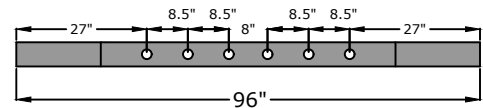

Approved for Production

Project: _____

Date: _____

Quantity: _____

By: _____

BARGER PRECAST

Specifications

Concrete: 5,000 psi minimum strength (28 day)

Pipe Penetrations: All pipe penetrations are placed according to job requirements.

6-Gang $\frac{3}{4}$ " Meter Vault Barger Precast Standard

P.O. Box 370 - Kingston TN 37763
Phone 888.882.5860 - BargerPrecast.com

Date: 3.172025

Drawn By: Aiden Barger

Approx. Empty Vault Weight: 3,100 lbs.

SUBMITTAL DATA SHEET

NL Ball Style Corporation Stop – 74101BCAPP

AWWA/CC x MNPT

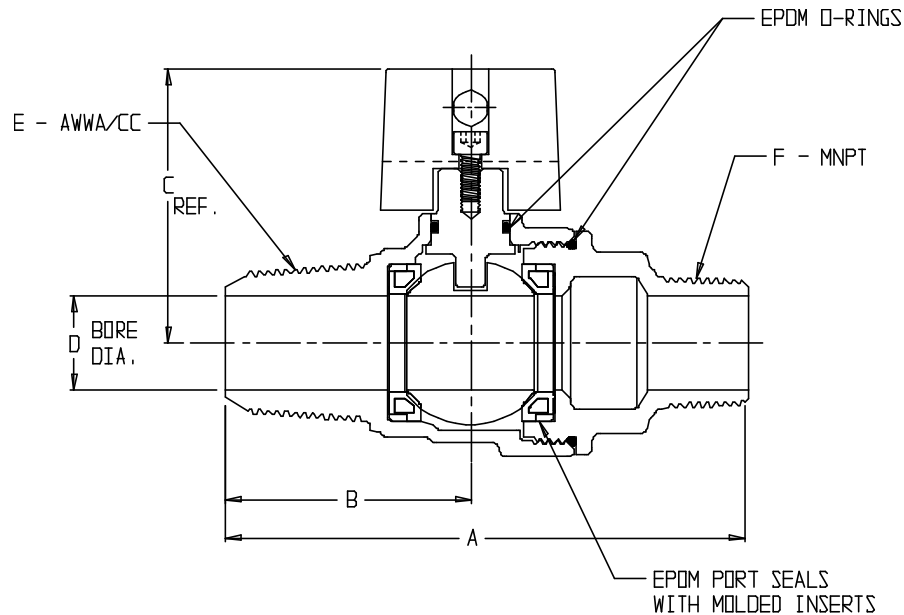

MODEL	SIZE	A	B	C	D	E	F
74101BCAPP	3/4	4.16	1.96	2.20	.75	3/4	3/4
74101BCAPP	1	4.59	2.11	2.40	1.00	1	1
74101BCAPP	1 1/2	6.42	3.05	3.30	1.50	1 1/2	1 1/2
74101BCAPP	2	6.75	3.21	3.60	2.00	2	2

SUBMITTAL INFORMATION

- Manufactured in compliance with ANSI/AWWA C800 (latest revision)
- Brass components in contact with potable water conform to ASTM B584, UNS C89833 (latest revision) and identified with “NL”
- Certified to NSF/ANSI 61 and NSF/ANSI 372
- Brass components not in contact with potable water conform to ASTM B62 and ASTM B584, UNS C83600 -85-5-5-5 (latest revision)
- PTFE coated brass ball rotates 360°
- Valve rated for 300 PSIG water pressure, end connections not to exceed rated pipe pressure.
- Blow out proof EPDM port seals
- End piece joint sealed with an EPDM o-ring and thread locker



A.Y. McDonald Mfg. Co.
4800 Chavenelle Rd
Dubuque, IA 52002

Toll Free: 1-800-292-2737
sales@aymcdonald.com
aymcdonald.com

A.Y. McDonald considers the information on this assembly drawing correct when published. Item and option availability, including specifications, are subject to change without notice.

Submitted by:

SUBMITTAL DATA SHEET

NL Meter Setter – 720-207WDDD 33

Double Purpose X Double Purpose

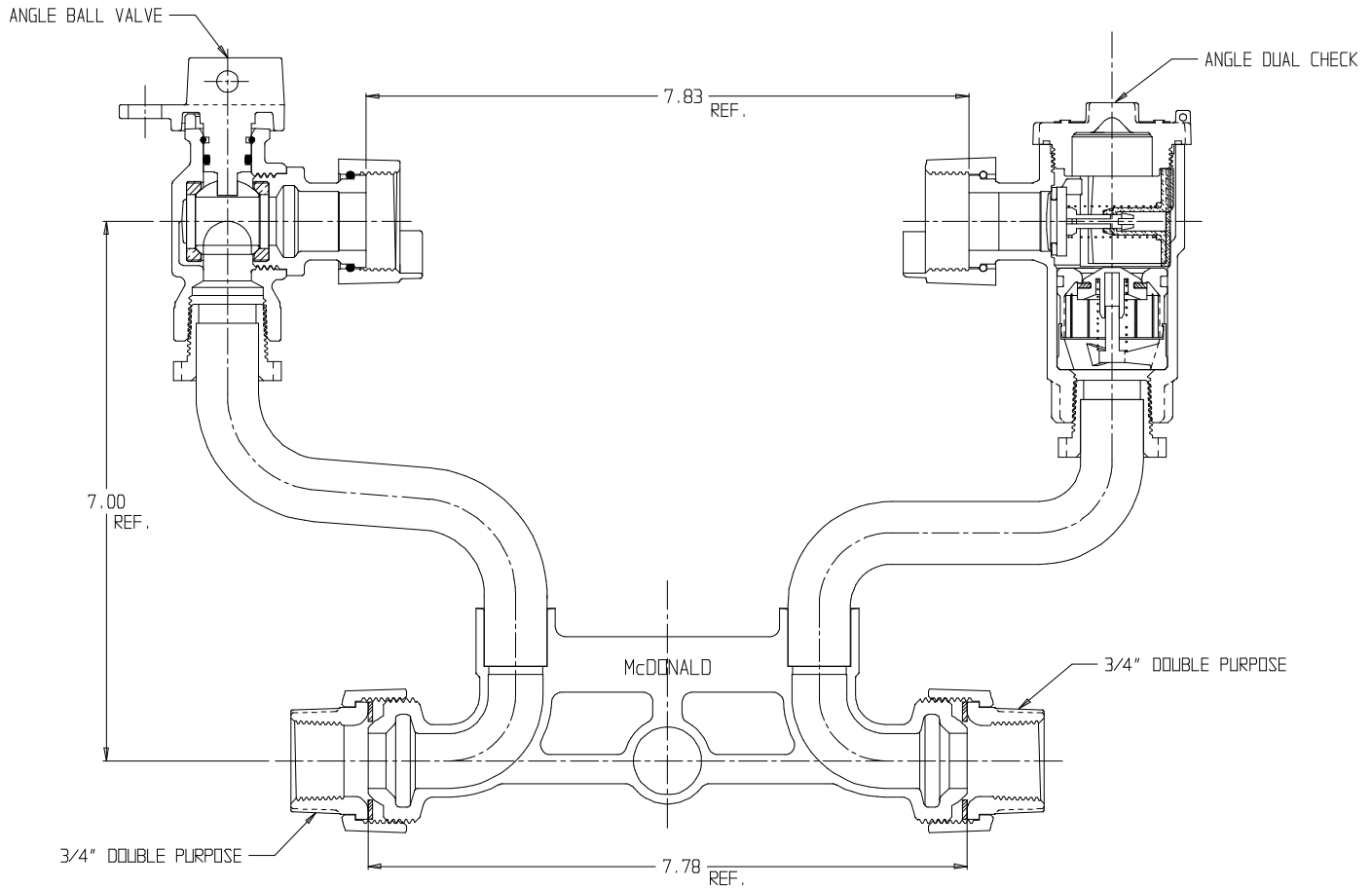

SUBMITTAL INFORMATION

- Manufactured in compliance with ANSI/AWWA C800 (latest revision)
- Brass components in contact with potable water conform to ASTM B584, UNS C89833 (latest revision) and identified with "NL"
- Certified to NSF/ANSI 61 (reference height restrictions) and NSF/ANSI 372
- Brass components not in contact with potable water conform to ASTM B62 and ASTM B584, UNS C83600 -85-5-5-5 (latest revision)
- Copper tubing made in compliance with ASTM B75 or B88, UNS C12200 (latest revision)
- Lead free solder joints
- Designed to provide proper meter spacing for ease of installation
- Padlock wings standard on all valves



A.Y. McDonald Mfg. Co.
4800 Chavenelle Rd
Dubuque, IA 52002

Toll Free: 1-800-292-2737
sales@aymcdonald.com
aymcdonald.com

A.Y. McDonald considers the information on this assembly drawing correct when published. Item and option availability, including specifications, are subject to change without notice.

Submitted by:

09-14

SUBMITTAL DATA SHEET

No-Lead Threaded Red Brass Pipe Nipples 2200 NPT x NPT



A.Y. McDonald Mfg. Co. No-Lead Brass Pipe Nipples can be used in above ground or underground applications. All pipe nipples are certified to contain <.25% lead by weight.

Part No.	Size	Part No.	Size	Part No.	Size	Part No.	Size	Part No.	Size
4422-478	1/8" x Close (3/4")	4422-338	1/2" x Close (1 1/8")	4422-372	1" x Close (1 1/2")	4422-404	1 1/2" x Close (1 3/4")	4422-489	2 1/2" x Close (2 1/2")
4422-479	1/8" x 1 1/2"	4422-339	1/2" x 1 1/2"	4422-373	1" x 2"	4422-405	1 1/2" x 2"	4422-472	2 1/2" x 3"
4422-480	1/8" x 2"	4422-340	1/2" x 2"	4422-374	1" x 2 1/2"	4422-406	1 1/2" x 2 1/2"	4424-261	2 1/2" x 3 1/2"
4422-481	1/8" x 2 1/2"	4422-341	1/2" x 2 1/2"	4422-375	1" x 3"	4422-407	1 1/2" x 3"	4422-473	2 1/2" x 4"
4422-482	1/8" x 3"	4422-342	1/2" x 3"	4422-376	1" x 3 1/2"	4422-408	1 1/2" x 3 1/2"	4424-262	2 1/2" x 4 1/2"
4422-483	1/8" x 3 1/2"	4422-343	1/2" x 3 1/2"	4422-377	1" x 4"	4422-409	1 1/2" x 4"	4422-490	2 1/2" x 5"
4422-484	1/8" x 4"	4422-344	1/2" x 4"	4422-378	1" x 4 1/2"	4422-410	1 1/2" x 4 1/2"	4424-264	2 1/2" x 6"
4422-485	1/8" x 4 1/2"	4422-345	1/2" x 4 1/2"	4422-379	1" x 5"	4422-411	1 1/2" x 5"	4424-265	2 1/2" x 8"
4422-486	1/8" x 5"	4422-346	1/2" x 5"	4422-380	1" x 5 1/2"	4422-412	1 1/2" x 5 1/2"	4424-266	2 1/2" x 10"
4422-487	1/8" x 5 1/2"	4422-347	1/2" x 5 1/2"	4422-381	1" x 6"	4422-413	1 1/2" x 6"	4424-267	2 1/2" x 12"
4422-488	1/8" x 6"	4422-348	1/2" x 6"	4422-382	1" x 7"	4422-415	1 1/2" x 8"	4427-085	2 1/2" x 24"
		4422-349	1/2" x 7"	4422-383	1" x 8"	4422-416	1 1/2" x 9"		
4422-304	1/4" x Close (7/8")	4422-350	1/2" x 8"	4422-385	1" x 10"	4422-417	1 1/2" x 10"	4422-492	3" x Close (2 5/8")
4422-305	1/4" x 1 1/2"	4422-352	1/2" x 10"	4422-387	1" x 12"	4422-419	1 1/2" x 12"	4424-268	3" x 3"
4422-306	1/4" x 2"	4422-354	1/2" x 12"	4422-437	1" x 18"	4422-441	1 1/2" x 18"	4422-494	3" x 4"
4422-307	1/4" x 2 1/2"	4424-341	1/2" x 18"	4422-438	1" x 24"	4422-442	1 1/2" x 24"	4424-270	3" x 4 1/2"
4422-308	1/4" x 3"	4424-409	1/2" x 24"	4422-439	1" x 30"	4422-443	1 1/2" x 30"	4424-210	3" x 5"
4422-309	1/4" x 3 1/2"	4424-410	1/2" x 36"	4422-440	1" x 36"	4422-444	1 1/2" x 36"	4424-271	3" x 5 1/2"
4422-310	1/4" x 4"			4424-239	1" x 48"			4422-474	3" x 6"
4422-311	1/4" x 4 1/2"	4422-355	3/4" x Close (1 3/8")			4422-420	2" x Close (2")	4424-272	3" x 8"
4422-312	1/4" x 5"	4422-356	3/4" x 1 1/2"	4422-388	1 1/4" x Close (1 5/8")	4422-421	2" x 2 1/2"	4424-273	3" x 10"
4422-313	1/4" x 5 1/2"	4422-357	3/4" x 2"	4422-389	1 1/4" x 2"	4422-422	2" x 3"	4422-475	3" x 12"
4422-314	1/4" x 6"	4422-358	3/4" x 2 1/2"	4422-390	1 1/4" x 2 1/2"	4422-423	2" x 3 1/2"		
4422-316	1/4" x 8"	4422-359	3/4" x 3"	4422-391	1 1/4" x 3"	4422-424	2" x 4"	4422-496	4" x Close (2 5/8")
4422-318	1/4" x 10"	4422-360	3/4" x 3 1/2"	4422-392	1 1/4" x 3 1/2"	4422-425	2" x 4 1/2"	4424-274	4" x 3"
4422-320	1/4" x 12"	4422-361	3/4" x 4"	4422-393	1 1/4" x 4"	4422-426	2" x 5"	4424-276	4" x 4"
4424-338	1/4" x 18"	4422-362	3/4" x 4 1/2"	4422-394	1 1/4" x 4 1/2"	4422-427	2" x 5 1/2"	4422-476	4" x 6"
		4422-363	3/4" x 5"	4422-395	1 1/4" x 5"	4422-428	2" x 6"	4424-211	4" x 8"
4422-321	3/8" x Close (1")	4422-364	3/4" x 5 1/2"	4422-396	1 1/4" x 5 1/2"	4422-430	2" x 8"	4422-477	4" x 12"
4422-322	3/8" x 1 1/2"	4422-365	3/4" x 6"	4422-397	1 1/4" x 6"	4424-306	2" x 9"		
4422-323	3/8" x 2"	4424-361	3/4" x 6 1/2"	4422-398	1 1/4" x 7"	4422-445	2" x 10"		
4422-324	3/8" x 2 1/2"	4422-366	3/4" x 7"	4422-399	1 1/4" x 8"	4422-446	2" x 12"		
4422-325	3/8" x 3"	4422-367	3/4" x 8"	4422-401	1 1/4" x 10"	4424-304	2" x 16 3/4"		
4422-326	3/8" x 3 1/2"	4422-369	3/4" x 10"	4422-403	1 1/4" x 12"	4422-447	2" x 18"		
4422-327	3/8" x 4"	4424-305	3/4" x 10 1/2"			4422-448	2" x 24"		
4422-328	3/8" x 4 1/2"	4422-371	3/4" x 12"			4422-449	2" x 30"		
4422-329	3/8" x 5"	4424-307	3/4" x 15 1/2"			4422-450	2" x 36"		
4422-330	3/8" x 5 1/2"	4424-376	3/4" x 17"			4422-471	2" x 48"		
4422-331	3/8" x 6"	4422-433	3/4" x 18"			4422-491	2" x 72"		
		4424-386	3/4" x 20"						
		4422-434	3/4" x 24"						
		4422-435	3/4" x 30"						
		4422-436	3/4" x 36"						

SUBMITTAL INFORMATION

- 200 PSI Cold Water Application
- Brass pipe diameters range from 1/8" through 4"
- Lengths range from 3/4" through 72"
- Schedule 40 wall thickness
- Material - C23000

- Conforms to:
 - ASTM B687 (Pipe Nipple Standard)
 - ANSI/ASME B1.20.1 (National Pipe Thread Standard)
 - ASTM B43 (Standard Sizes)



Meets the Requirements of
NSF/ANSI/CAN 61 & 372

NO-LEAD: The weighted average of the wetted surface of this no-lead product contacted by consumable water contains less than one quarter of one percent (0.25%) lead.



A.Y. McDonald Mfg. Co.
4800 Chavenelle Rd
Dubuque, IA 52002

Toll Free: 1-800-292-2737
sales@aymcdonald.com
aymcdonald.com

A.Y. McDonald considers the information on this assembly drawing correct when published. Item and option availability, including specifications, are subject to change without notice.

Submitted by: